

This is our installation guide for the following products below.

These bracket installations should be done **before tiling.**



Bowl



Bowl Two Tone

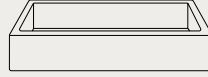

Box

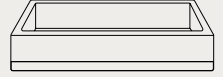

Box Two Tone



Cast



Cube



Funl



Hoop



Hoop Raw

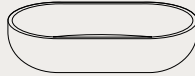

Isla

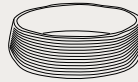

Mill

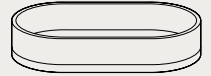

Pill



Prism Circle

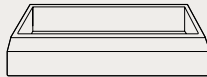

Prism Rectangle

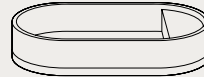

Shelf Oval

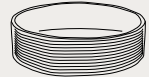

Slip

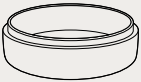

Stepp Circle

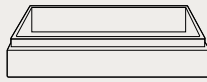

Stepp Rectangle



Tubb

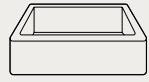

Vesl Square

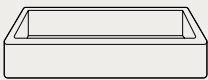

Vesl Rectangle

What's in your box:

Wall mount basin kit

Your selected
concrete basin
(design varies per basin)

Mounting
Bolts



Do not place tools, taps and mixers inside or near the basin at any time.

Damage inflicted by doing so is not covered by our warranty.

Glue

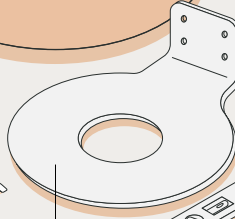
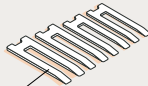
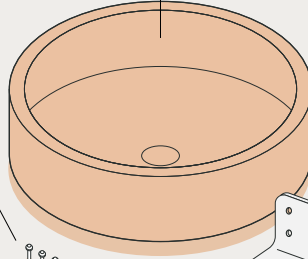

Assorted
Horseshoe
packers

Spirit
level

Wall mount
bracket
(design varies per basin)

01

Use packer to level bracket if required

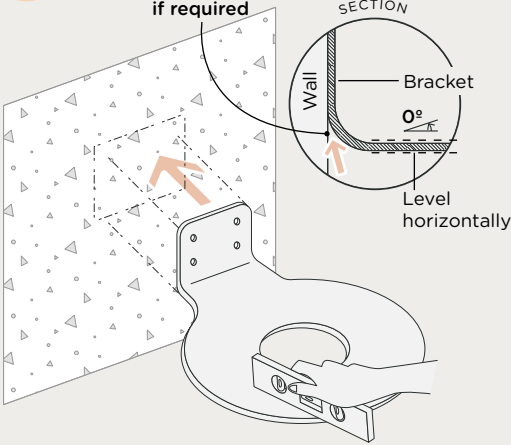

Mount bracket before tiling, ensuring bracket is placed at level height.

02

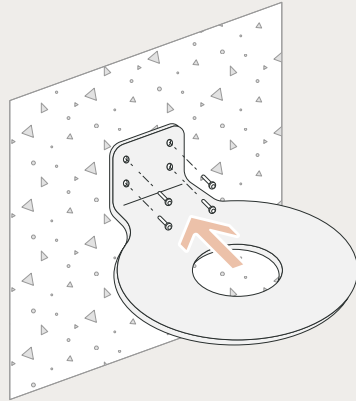

Bolt bracket to substrate wall.

03

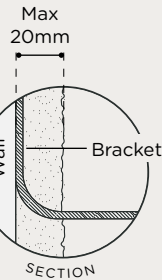

Screed (20mm max) and tile over mount bracket.

04

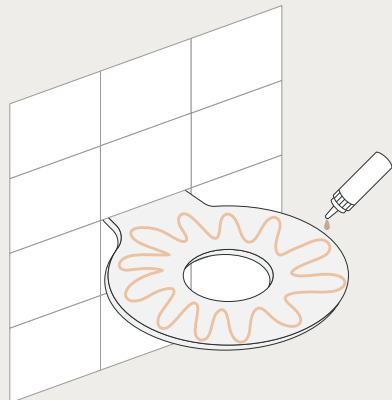

Apply glue provided to the mount bracket.

05

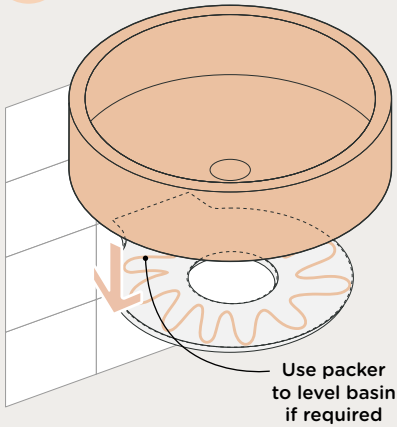

Lower basin onto mount bracket, ensuring basin is centrally placed.

06

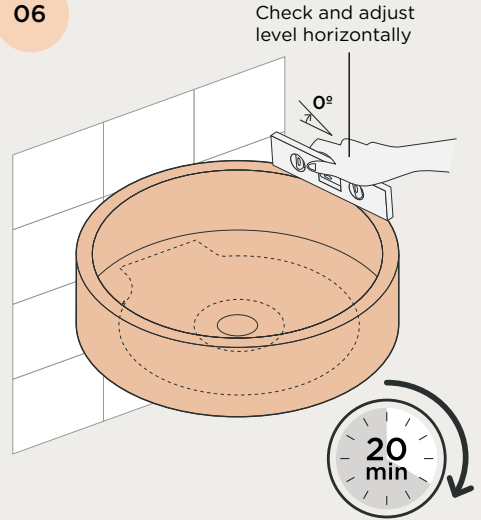

Working time for adhesion dry to touch: 20 mins.

07

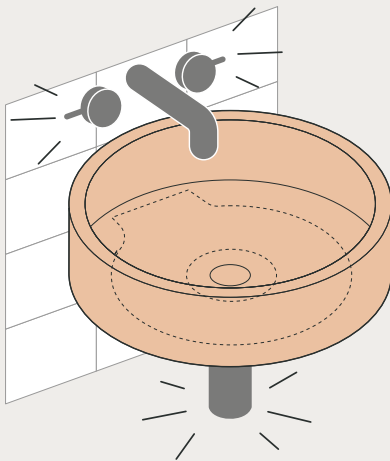

Carefully fit plumbing fixtures while glue dries.

Got a question? Drop us a line, we're here to help!

info@noodco.com.au

noodco.com.au